

**Saramonic®**

UHF Wireless  
Microphone System  
UwMic10

## Statement

This user manual is available for these packages:

- UwMic10 RX10+TX10, a portable receiver and a body-pack transmitter.
- UwMic10 RX10+TX10+TX10, a portable receiver and two body-pack transmitters.
- UwMic10 HU10, a hand-held microphone transmitter.
- UwMic10 TX10, a body-pack transmitter.

Please read this manual carefully before using and strictly operate and store in accordance with the instructions. Please save it for your future reference.

If the user manual can not help you to solve certain problems, please ask your retailer for help or email us: [info@saramonic.com](mailto:info@saramonic.com).

## Cautions

1. Do not use the unit under water, don't expose it to rain. Please store it in a cool, dry place.
2. Please use and store it in normal temperature. Do not move it from overheated to supercooled condition frequently as well as keep away from heat sources such as heater and oven.
3. When using and storing, please pay attention to dust and moisture.
4. Be careful to violent collision.
5. To avoid acoustical feed-back, do not hold the microphone close to the loudspeakers.
6. For the best sound pick-up pattern do not hold your hand against the microphone head.
7. Remove the batteries from the battery compartment when the device is not used for a long time.

# CONTENTS

<b>General Introduction</b> .....	<b>2</b>
<b>Portable Receiver UwMic10-RX10</b> .....	<b>2</b>
Introduction .....	2
Product Structure.....	2
Attaching Accessories .....	4
LCD Display Operation Guide .....	5
<b>Body-pack Transmitter UwMic10-TX10</b> .....	<b>8</b>
Introduction .....	8
Product Structure.....	8
Attaching Accessories .....	10
LCD Display Operation Guide .....	11
<b>Hand-held Microphone UwMic10-HU10</b> .....	<b>14</b>
Introduction .....	14
Product Structure.....	14
Setup Guide .....	15
<b>Operation Guide</b> .....	<b>16</b>
<b>Specification</b> .....	<b>20</b>
Receiver RX10.....	20
Transmitter TX10 and HU10 .....	21
<b>Packing list</b> .....	<b>22</b>

## General Introduction

The Saramonic UwMic10 UHF wireless microphone system is intended for portable wireless operation and can be used in several environments for applications such as DSLR video, field recording, broadcast TV, electronic news gathering (ENG), on-the-spot interviews, and more.

## Portable Receiver UwMic10-RX10

### Introduction

The Saramonic UwMic10-RX10 is a camera-mountable integrated wireless receiver. It features a wide switching RF bandwidth, an easy-to-read LCD display and infrared synchronization between transmitter and receiver.

Equipped with an auto-scan function, the RX10 can automatically search for an available transmission frequency. The phone jack enables real-time monitoring of receiver via headphones, especially useful for cameras that lack a monitor output.

### Product Structure

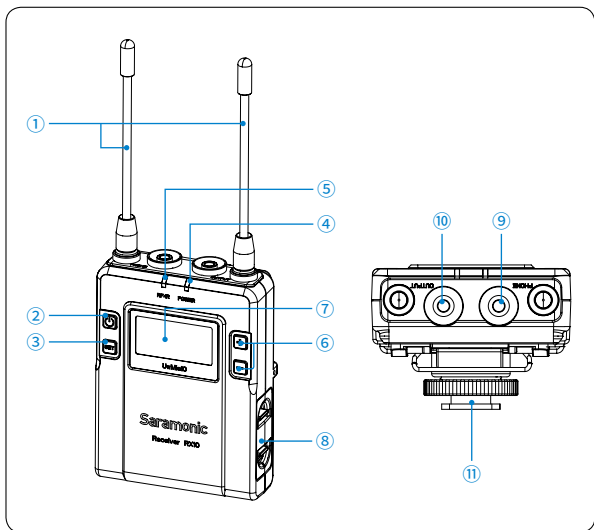

- ① **Antennas**
- ② **Power button**  
Press to turn on or off the RX10.
- ③ **SET button**  
Long press the SET button to enter the displayed menu.  
Then, short press the SET button to confirm your option or long press again to exit without saving.
- ④ **POWER indicator**  
Indicates the battery level as follows:  
Green light: Sufficient battery level.  
Red light: Low battery level.
- ⑤ **RF indicator and infrared transmitter port**  
The infrared transmitter port sends the set frequency to a transmitter.  
RF indicator displays the RF input level as follows:  
Green light: RF signal is strong.  
Red light: RF signal is weak or disconnected.
- ⑥ **+ or - button**  
Selects functions or values shown on the display.
- ⑦ **LCD display**  
Display menus, please refer to "LCD Display Operation Guide" (page 5) for more details.
- ⑧ **Battery compartment**  
Operates on two AA batteries (not included).
- ⑨ **PHONE jack**  
It is a 3.5mm diameter and stereo mini headphone jack.  
Connect a headphone to monitor the audio output.

Note: Please do not connect a headphone with a monaural mini jack. As this may short-circuit the headphone jack and distorted sound output.
- ⑩ **OUTPUT jack**  
Connect the RX10 to a video camera, camcorder, mixer or amplifier with the supplied output cable.
- ⑪ **Standard cold shoe**

## Attaching Accessories

- 1 Connect the supplied cable to the output jack.

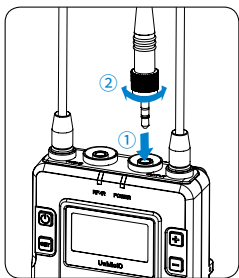

- ① Plug the supplied cable into the OUTPUT jack.
- ② For a secure connection, turn to lock the connector.

- 2 Attach a belt clip. Please Refer to "Attaching Accessories" (page 10).

- 3 Attach the shoe mount adapter.

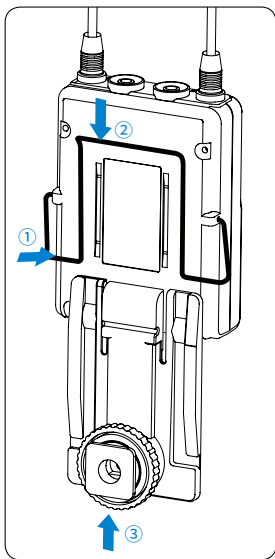

- ① Please attach the belt clip upside-down before attaching the shoe mount adapter.
- ② Push the bottom of the belt clip to make some space between the belt clip and the receiver.
- ③ Align the belt clip with the two vertical grooves on the shoe mount adapter and insert the adapter in the direction of the arrow.
- ④ Push the shoe mount adapter in fully until the belt clip fits into the horizontal groove on the adapter holds.

## LCD Display Operation Guide

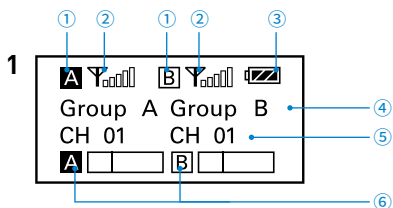

**Home screen.** If no operation is performed for 20 seconds on the other screens, the display will automatically return to the home screen.

- ① Group icon
  - Indicates the power of group A is turned off.
  - Indicates the power of group A is turned on.
- ② RF level indicator  
Indicates the current reception level.
- ③ Battery level indicator  
Displays the battery level. Please replace both batteries immediately when the indicator starts flashing.
- ④ Name of the channel group
- ⑤ Current channel  
Displays the current channel number.
- ⑥ Audio input level meter  
Displays the audio input level.

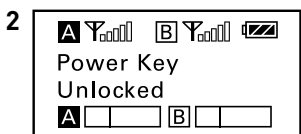

**Power key.** Long press the SET button to unlocked or locked the power key. Lock the power key to prevent the receiver being turned off unwittingly while using.

- **Unlocked:** Long press the power key to turn the receiver on or off (System default).
- **Locked:** The receiver will not be turned off even after pressing the power key.

Note: If the batteries are removed and reinserted while the power key is set to Locked, the lock state of the Power key will not be changed. You can turn on the receiver by long pressing the power button.

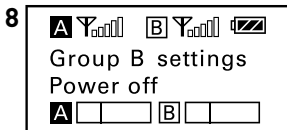
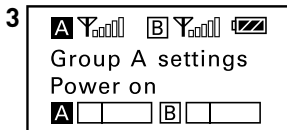

**Power of the Group.** When you only use one group signal, please turn off the other group to save battery. To save battery, system default of the Group B is power off while the Group A is power on.

When operating two transmitters simultaneously, please set each transmitter to a different group to prevent interference or noise.

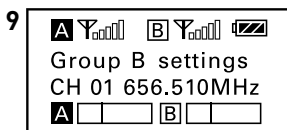
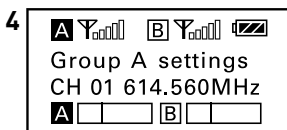

**Select channel.** Details of operation, please refer to "Manually setting the receiver channel" (page 18).

The system default of Group A is in RF frequency 614.560MHz, Channel 01.

The system default of Group B is in RF frequency 656.510MHz, Channel 01.

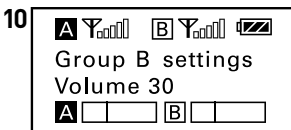
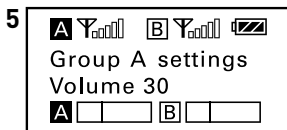

**Set output volume.** Set the volume of output audio within the range 0 to 30. The setting is retained even after the power is turned off. Default is 30.



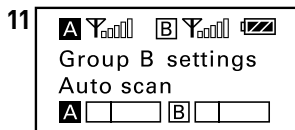
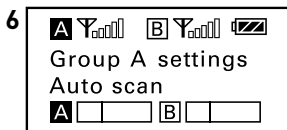

**Auto scan function.** Automatically scan an available and clear channel. Details of operation, please refer to "Using the auto scan function" (page 17).

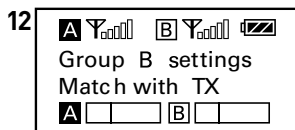
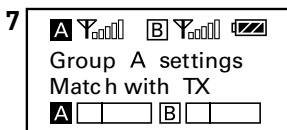

**Infrared matching function.** Match the receiver and transmitter via infrared. Details of operation, please refer to "Match the channel of receiver and transmitter" (page 18).

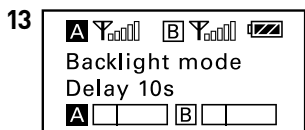

**Set backlight.** Set the background LED light to ON or Delay 60 /30 /10 seconds or OFF. Default is "Delay 10s."

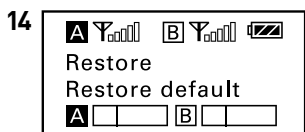

**Restore settings.** Confirm it then the parameters of RX10 are restored to their factory default settings.

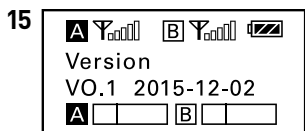

**Version of the UwMic-RX10.**

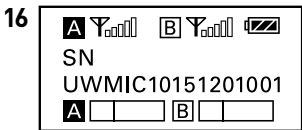

**Serial Number.**

## Body-pack Transmitter UwMic10-TX10

### Introduction

This transmitter is a compact transmitter that employs a crystal-controlled PLL synthesizer. It is equipped with a muting function and a BMP-type microphone input connector. The RF power output can be switched among high, middle and low.

### Product Structure

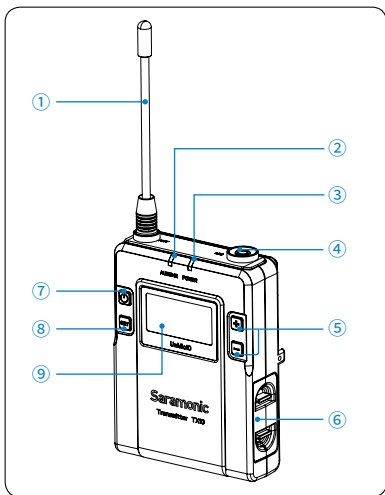

① **Antenna**

② **AUDIO indicator / IR (infrared detector)**

AUDIO indicator: Indicates the audio input level.

IR (infrared detector): Gets the frequency from the receiver

Solid Green: Audio input level is appropriate.

Flashing Red: Audio is muted (i.e., disabled).

For details on setting the mute function, please refer to "Set Mute key" (page 12).

③ **POWER indicator**

Indicates the battery level as follows:

Solid Green: Sufficient battery level.

Solid Red: Battery is getting low.

④ **Audio input connector (BMP type)**

Connect to the supplied lavalier microphone.

⑤ **+ or - button**

Selects functions or values shown on the display.

⑥ **Battery compartment**

Accepts two AA batteries (alkaline, nickel metal hydride, or lithium batteries).

⑦ **Power / Mute button**

Function	Operation
Power ON	Press button for one second or longer
Power OFF	Press button until it turns off
Mute ON	Short press button
Mute OFF	

⑧ **SET button**

Long press the SET button to enter the displayed menu.

Then, short press the SET button to confirm your option or long press again to exit without saving.

⑨ **LCD display**

Display menus, please refer to "LCD Display Operation Guide" (page 11) for more details.

## Attaching Accessories

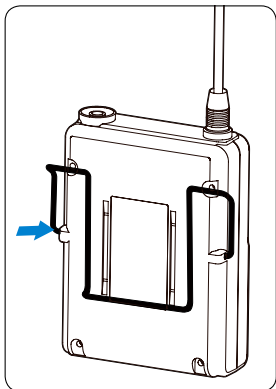

### 1 Attach a belt clip.

Insert one end of the belt clip into one of two holes on either side of the transmitter, and then insert the other end into the hole on the other side.

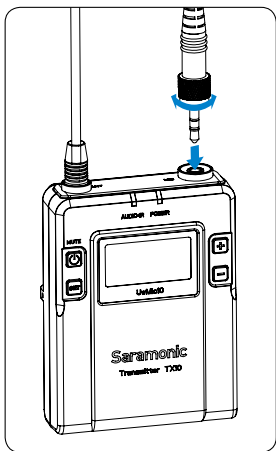

### 2 Connect the microphone.

For a secure connection, turn to lock the connector.

Note: Please turn off the transmitter before attach or remove the microphone.

## LCD Display Operation Guide

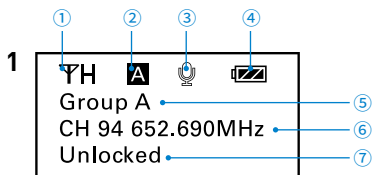

**Home screen.** If no operation is performed for 20 seconds on the other screens, the display will automatically return to the home screen.

- ① RF transmission power indicator  
Indicates the current transmission power level.  
For details on setting the level, please see “Select RF power level” (page 12).
- ② Channel group indicator  
Indicates the channel group.
- ③ Mute indicator  
🔇 Mute OFF    🔇 Mute ON
- ④ Battery level indicator  
Displays the battery level. Please replace both batteries immediately when the indicator starts flashing.
- ⑤ Name of the channel group
- ⑥ Channel and frequency  
Indicate the current channel and frequency.
- ⑦ The statue of Power / Mute button.

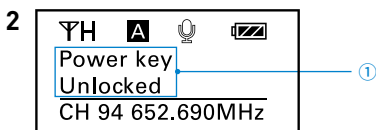

- ① Menu display section. Displays various functions. Press the + or - button to switch functions.

**Set Power key.** Select Unlocked or Locked.

Set “Locked” to lock the power button to prevent the unit being turned off or muted unwittingly while using. Default is “Unlocked.”



**Select Channel.** There are 96 channels with carrier frequency ranging from 614MHz to 696MHz. Default is “Channel 01” and “614.560MHz.”



**Select Group.** You can choose “A” or “B” channel group. Each group has 96 channels. Default is “Group A.”



**Select RF power level.** You can set the transmitted RF power to High, Middle or Low. Default is “High.”



**Set Mute key.** If you want to mute the audio, please select “Enable” first and then short press the power button. Default is “Enable.”



**IR Match.** Set to match with the receiver. The screen will display “Matching” when in process. After successful matching, it will indicate “Match finished.”



**Set Backlight.** Select ON, OFF or Delay 10 / 30 /60 seconds. Default is “Delay 10s.”



**Restore default setting.**



**Version of the UwMic10-TX10.**



**Serial Number.**

# Hand-held Microphone UwMic10-HU10

## Introduction

Saramonic HU10 is a handheld wireless UHF microphone transmitter features a compact metallic body, an easy-to-read LCD display, a RF power switch and a PLL synthesizer. The broadcast quality microphone will capture crystal clear and rich sound. It has a built-in antenna, a muting function and power lock function. The channel of HU10 is synced up with the receiver via infrared.

## Product Structure

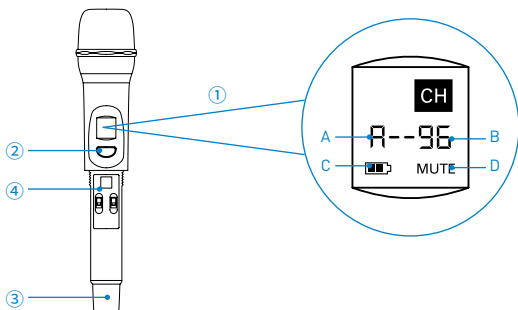

### ① LCD screen

- A. Channel Groups.  
Two channel groups: A and B.  
Each group has 96 channels.
- B. Channel number.
- C. Battery level indicator.
- D. MUTE. Audio is muted.

This LCD display indicates it is operating on channel 96 of group A.

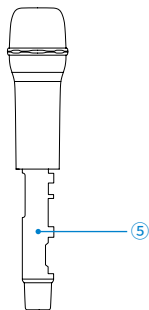

### ② Power / Mute button

Power: Long press to turn on/off the HU10.

Mute: Short press the button while transmitting, the audio will be muted. Press it again to restore the audio output.

Note: In muting, the audio signal is not output but an RF signal is still transmitted.

### ③ Antenna



#### ④ Operation panel

- A. Infrared detector. Receives the frequency set on the receiver.
- B. Lock switch. Set to ON will lock the power button. It will prevent the power being turned off inadvertently during transmission.

Note: The lock switch will not lock the mute function.

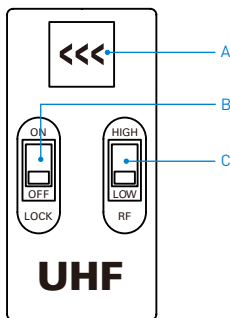

- C. RF power. Set the transmit output level to HIGH or LOW.

#### ⑤ Battery compartment

Operates on two AA batteries (not included).

You could use alkaline, lithium or nickel metal hydride batteries.

### Setup Guide

- 1 Install the batteries. Refer to "UwMic10-HU10" (page 16).
- 2 (Option) Set the lock switch to ON or OFF.
- 3 (Option) Set the RF power to HIGH or LOW. The transmit power level varies depending on the model.
- 4 Press the power button to turn on the HU10.
- 5 Turn on the receiver UwMic10-RX10 and sync with the transmitter HU10. Details of operation, please refer to "For HU10" (page 19).
- 6 When sync successfully, the screen of HU10 will show the group and channel same as the receiver.
- 7 Close the grip in the direction of the arrows.

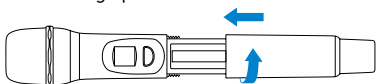

- 8 Now it is ready to use.

## Operation Guide

### 1 Install the batteries.

#### ① UwMic10-RX10 and UwMic10-TX10:

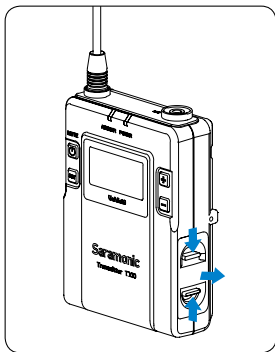

- Long press the Power key to turn the unit off.
- Slide the two catches inward and pull out the battery compartment.
- Insert two AA size batteries according to the polarity indicators and close the compartment. Please be sure the battery compartment is locked securely.

#### ② UwMic10-HU10

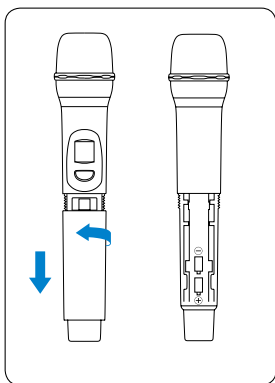

- Long press the power button to turn the power off.
- Turn the grip in the direction of the arrow, and pull the grip down until the battery compartment is visible.
- Insert two new AA batteries into the battery compartment with  $\oplus$  and  $\ominus$  polarities in the correct orientation.

#### Note:

- ① Please remove the batteries from the battery compartment when the device is not used for a long time.
- ② Please always use sets of the same type of battery.
- ③ Replacing the batteries during operation may generate noise. Please make sure that the unit is turned off before replacing batteries.

**2 Connect the receiver to the mic jack of a camera, camcorder or mixer with the supplied cable.**

**3 Turn on the receiver by long pressing the power button.**

**4 Set the channel of the receiver by two ways:**

① Using the auto scan function

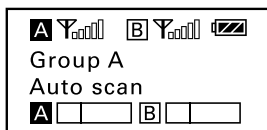

- Use the + or – button to display the auto scan screen on the receiver.

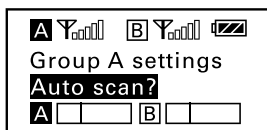

- Long press the SET button to select "Auto scan?"

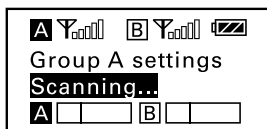

- Press the SET button to confirm.

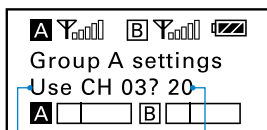

- The channel with the least noise and interference will be displayed.

A. Indicates the current least noise channel is CH 03 and ask you if you would like to use it. You can short press the SET button to confirm the channel in 20 seconds or long press the SET button to exit the displayed menu without saving.

B. Counting down 20 second

Note:

- ① After 20 seconds have elapsed, the display returns to the home screen without saving.
- ② Some noise may occur when power is turned on, you could turn down the audio input level of devices connected to the receiver accordingly.

② Manually setting the receiver channel.

- Use the + or – button to display the channel menu on the receiver.

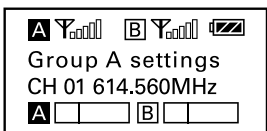

- Long press the SET button to select the menu.

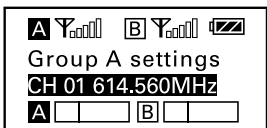

- Use the + or – button to select the desired channel and confirm it by short pressing the SET button.

## 5 Match the channel of receiver and transmitter.

- ① Using infrared transmission to transfer the frequency set on the receiver to a transmitter.

### For TX10

- Turn on the transmitter by long pressing the power button.
- Use the + or – button to display the “Match with TX” menu on receiver.

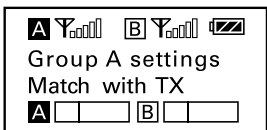

- Use the + or – button to display the “Match with RX” menu on transmitter.



- Both long press the SET button to select the menu and short press it to confirm.
- Place the infrared transmitter port on the receiver near the infrared detector on the transmitter.
- If "Match finished" displayed on the LCD screen, the frequency for use on the transmitter is set.
- After matching successfully, press the SET button of receiver to return to the previous menu.

#### For HU10

- Turn the transmitter power on.
- Use the + or - button to display the "Match with TX" menu on receiver.

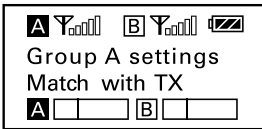

- Place the infrared transmitter port on the receiver near the infrared detector on the transmitter.
- If sync successfully, the group and channel of HU10 are the same as the receiver's.
- After matching successfully, press the SET button of receiver to return to the previous menu.

Note: When using the infrared link, please place the receiver and transmitter within about 20cm of each other within 20 seconds. After 20 seconds have elapsed, the infrared transmission finishes and the display returns to the previous menu.

② Manually setting the transmitter channel (Only available on the UwMic10-TX10).

- Turn on the transmitter by long pressing the power button.
- Use the + or – button to display the channel setting menu on the transmitter.

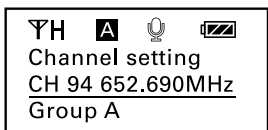

- Long press the SET button to select the menu.
  - Use the + or – button to select the same channel as the receiver and confirm it by short pressing the SET button.
- 6** Attach the accessories you need for the receiver and transmitter. Refer to "Attaching Accessories" (page 4 and page 10).
- 7** You are ready to record.

## Specification

### Receiver RX10

Channel number	96
Channel group	A and B
Oscillator type	PLL synthesizer
Audio output connector	3.5 mm mini jack
Antenna	1/4λ wire antenna
Audio output level	-60 dBV
Headphone output level	30mW (16 Ω)
Receive frequencies	614 MHz - 696 MHz
Receive sensitivity	-95 dBm
Signal to noise ratio	70 dB or more
Voice delay	12 ms
Reference deviation	±5 kHz (-60 dBV, 1 kHz input)
Frequency response	40 Hz to 18 kHz (+/-3dB)
Distortion	0.5% or less

Spur suppression	-60 dB
Weight	Approx. 218.7g (excluding batteries)
Battery	Two AA size batteries
Dimensions	170.9 × 63.5 × 30.0 mm
Operating temperature	0 °C to 50 °C
Storage temperature	-20 °C to +55°C

## Transmitter TX10 and HU10

Channel number	96
Channel group	A or B
Oscillator type	PLL synthesizer
Carrier frequencies	614 MHz - 696 MHz
Reference deviation	±5 kHz (-60 dBV, 1 kHz input)
Signal to noise ratio	70 dB or more
Spur suppression	-60 dB
Voice delay	12 ms
Antenna	1/4λ wire antenna
Audio input connector	TX10: 3.5mm mini jack
	HU10: none
Reference audio input level	-60 dBV (MIC input, 0 dB attenuation)
RF output level	30mW/20mW/10mW selectable
Distortion	0.5% or less
Weight	TX10: Approx. 211.4g (excluding batteries)
	HU10: Approx. 338.2g (excluding batteries)
Battery	Two AA size batteries
Dimensions	TX10: 170.9 × 63.5 × 30.0 mm
	HU10: 254.0 × 52.0 × 52.0 mm
Operating temperature	0°C to 50°C
Storage temperature	-20°C to +55°C

## Packing list

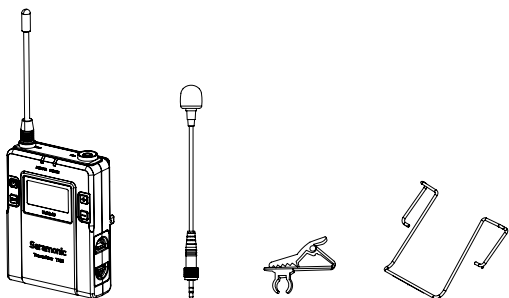

### TX10

- Body-pack transmitter: TX10
- Omni-directional lavalier microphone
- Microphone holder clip
- Wind screen
- Belt clip



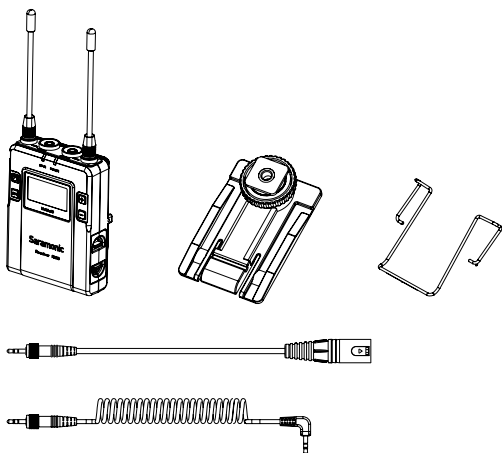

#### RX10

- Portable receiver: RX10
- Shoe mount adapter
- Belt clip
- XLR-BMP audio output cable
- 3.5mm plug-bmp audio cable

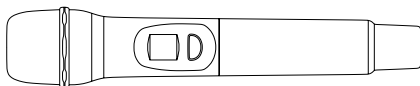

#### HU10

- Hand-held microphone: HU10

Warranty card

User manual





**[www.saramonic.com](http://www.saramonic.com)**

The Saramonic logo is trademark which is registered and owned by Saramonic International.

COPYRIGHT 2011-2021 SARAMONIC INTERNATIONAL ( A brand of DSQN )

Email: [info@saramonic.com](mailto:info@saramonic.com)